



PLOUGHING GUIDE

by

Alan Jones

Kverneland Group UK Ltd.

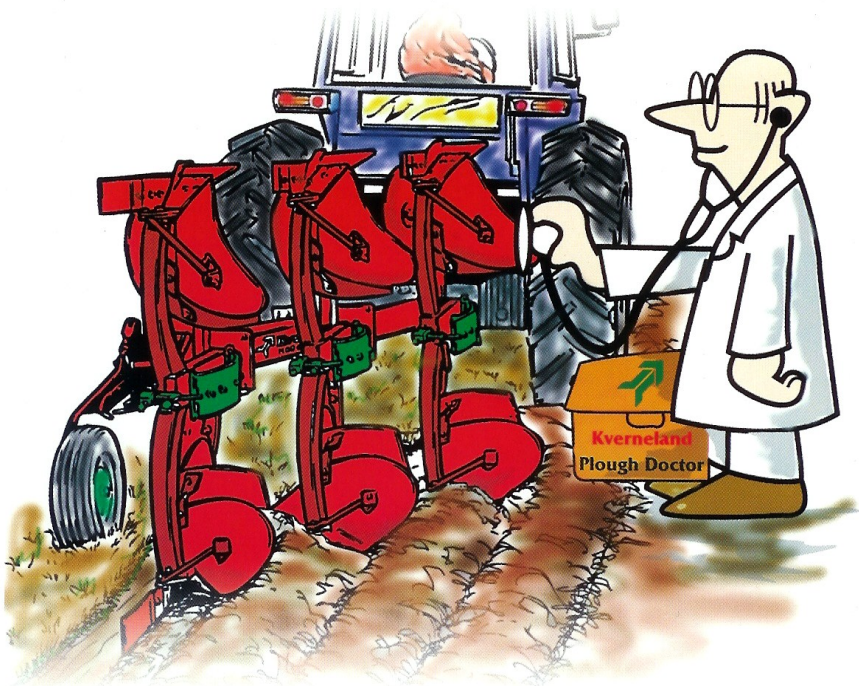

**The secret of successful ploughing:-
Correct maintenance, preparation and
plough settings**

Before you can achieve good ploughing it is essential that both the tractor and plough are properly prepared. The tractor should have the correct wheel settings and, if using a reversible plough, equal tyre pressures on both axles. Tractor front-end ballast may be required for stability but most important, efficient operation of the tractor's hydraulic system.

The Tractor

Tyre pressure must be equal on the same axle for all reversible ploughs
Hydraulic male & female couplings must match to avoid back pressure
Enough hydraulic outlets must be available to operate all plough functions

The inside wheel settings must be equal, especially when using 4WD tractors
Rear 3-point linkage lift arms must be equal in length on reversible ploughs
Adequate horsepower for the size of plough is essential for optimum performance
Correct linkage geometry is essential – Cat II, Cat III or Cat IV for correct line of pull
Traction, stability and operation of hydraulic functions rely on adequate weight
Operation controls in the tractor must be selected to 'Draft' or 'Mix'
Rigid stabilisers are essential for correct operation of semi-mounted ploughs

In The Field

Important, always set disc coulters before skimmers for optimum performance
Never set skimmers deeper than 10cm and ensure all operate at the same depth
Test and adjust the plough's furrow width to the suit soil type being ploughed
Hydraulic functions must be checked prior to work for compatibility and operation
Ensure depth wheel adjusters are equal in length on reversible ploughs
Front furrow depth is set by the tractor's in-cab 3-point linkage control
Inclination of the plough will cause uneven furrows—plough leg to be 90° to the land
Ensure the front furrow width is equal to the plough setting for even furrows
Look closely for equal amounts of soil on mouldboards for furrow uniformity
Demonstration and operational success only follows good plough preparation

Know Your Plough

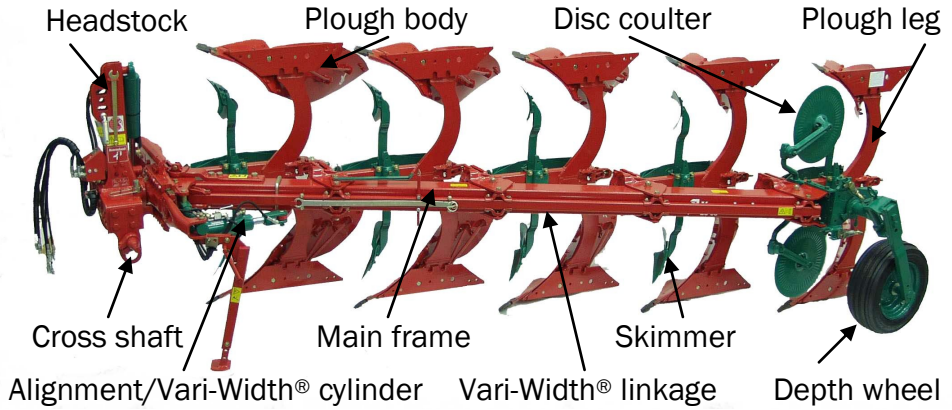

Plough Body Parts

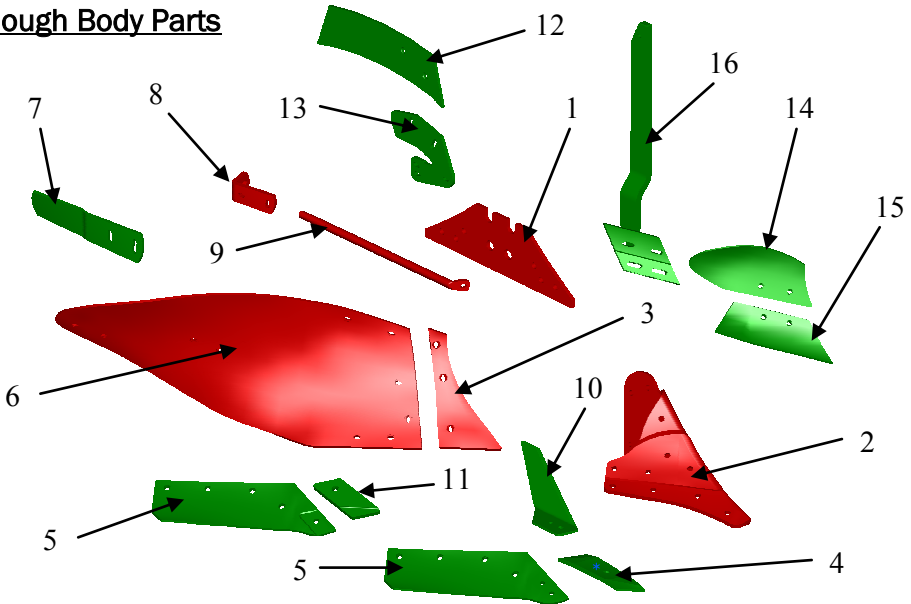

- | | | | |
|----|--------------------------------------|-----|------------------------------------|
| 1. | Landside | 9. | Mouldboard stay |
| 2. | Saddle (frog) | 10. | Sword share knife |
| 3. | Shin piece | 11. | Flush fit point (for sticky soils) |
| 4. | Reversible point | 12. | Trashboard |
| 5. | Share (flush fit & reversible point) | 13. | Trashboard mounting bracket |
| 6. | Mouldboard | 14. | Skimmer mouldboard |
| 7. | Mouldboard extension | 15. | Skimmer share |
| 8. | Mouldboard stay bracket | 16. | Skimmer stalk |

Know Your Plough

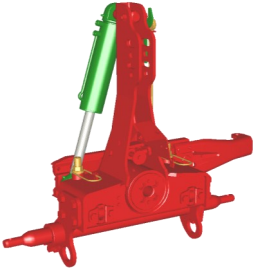

Headstock



Furrow splitter



Mouldboard extension



Skimmer (maize type)



Sword share knife

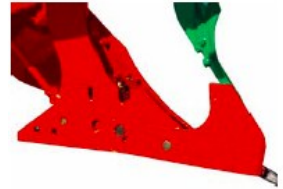

Sword landside



Disc coultter



Trashboard



Ecoshare



Furrow bottom widener



Rear depth wheel



Combined depth & transport wheel

Tractor Settings

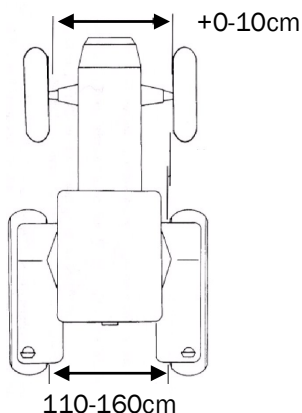

Tractor wheel setting

The front and rear inside wheel setting of the tractor is very important. Initially, they control the front furrow width of the plough. As the wheel setting is increased, the centre line of the tractor moves away from the furrow wall, thus increasing the width of the front furrow. Reducing the wheel setting has the opposite effect and narrows the front furrow width.

When ploughing with the tractor wheel in the furrow bottom, the tractor will lean towards the ploughed land. This is exaggerated when operating at depths above 8in. To ensure the tractor and plough pull in a straight line, it is recommended to adjust the front wheels 0-10cm wider than the rear. However, when using a 4WD tractor or when ploughing less than 7in deep, equal front and rear wheel settings can be advantageous as it helps to ensure the tractor and plough pull in a straight line.

Incorrect adjustment

Correct

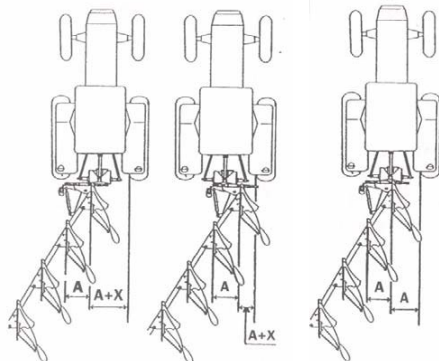

Front furrow width

During operation and with the tractor having the correct wheel setting for the plough being used, the front furrow width should be equal to all the remaining furrows. As it is impractical to continuously adjust the wheel setting, the plough is provided with a side shift system to simplify this adjustment.

See 'Basic Field Settings'

Tractor 3-point linkage geometry

For efficient plough operation and stability, it is essential that the tractor's 3-point linkage geometry and pulling point is correct. Incorrect linkage geometry will cause the plough to wander from side to side and can also affect the tractor's stability and performance.

Tractor linkage geometry will depend on the type of linkage category fitted.

Cross shaft length:

Cat II = 825mm, Cat III = 965mm

Cat IIIN = 825mm, Cat IV = 1165mm

Cat IVN = 965mm

(Special Cat III 860mm shaft available for Cat IIIN linkage)

TIP! This measurement is taken from the inside of the tractor link arm ball ends when fitted to an implement.

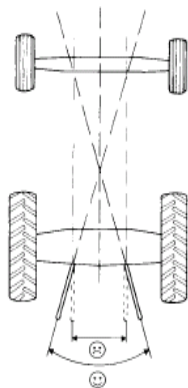

Plough Alignment

For a plough to work efficiently, all the bodies must be correctly aligned and parallel to one another. Incorrect settings will result in poor quality work and uneven component wear. Poor alignment will also cause the plough to pull out of line and affect the tractor steering.

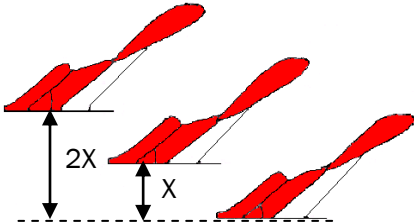

Furrow width

Using a straight edge against the rear landside, check the furrow width of each body. All bodies should be parallel to each other.

Always ensure the plough is fitted with new wearing parts for accurate measurement.

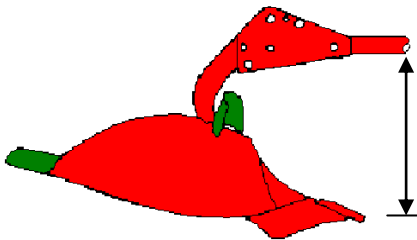

Underbeam clearance

Using a rule from the underside of a new point to the underside of the main frame.

Left hand bodies should be equal to right hand bodies on a reversible plough.

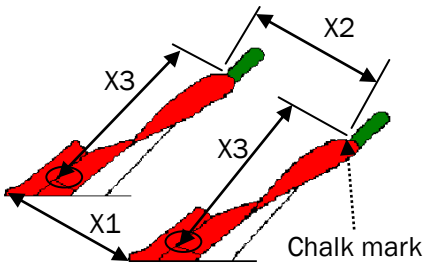

Interbody clearance

The body inlet should be equal to the outlet i.e. $X1 = X2$

Left bodies must be equal to right bodies on reversible ploughs. Measure from a non-wearing datum and then chalk a mark on the end of the mouldboards - X3. Adjust the mouldboard rear stays to correct setting X2. See: 'Mouldboard Adjustment'

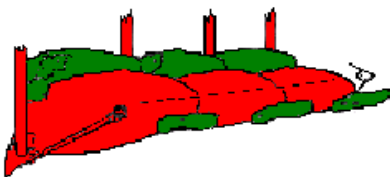

Mouldboard height

Using your eyes or string, the tops and bottoms of the mouldboards should be in a straight line. Adjust by slackening the mouldboard and stay bolts to correct.

Mouldboard Adjustment



Before you can achieve good ploughing, it is essential to check and adjust the mouldboard interbody clearance setting. This is to ensure that all the furrows are equal in size and height during operation.

Marking the mouldboards

Chalk mark each mouldboard end (both left and right) to find a common 'datum' point to work from. The measurement should be taken from a non wearing point such as the joint between the share, mouldboard and shin piece as indicated.

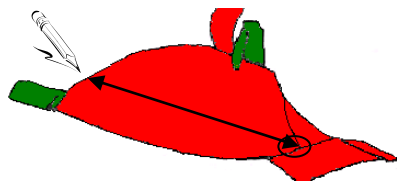

Adjusting right hand mouldboards

Starting from the centre body, loosen the mouldboard stay and adjust so that the mouldboard is in a neutral position - not pushed forward or pulled back. This is now the 'master' for all mouldboard measurements.

Measure accurately from the 'datum' chalk mark on the master mouldboard to the chalk marks on the mouldboards in front and behind. Adjust the mouldboard stays accordingly so that the mouldboard spacing is equal to the interbody clearance.

TIP! If the interbody clearance is not known, take this measurement from any common point on the main plough frame or leg assembly.

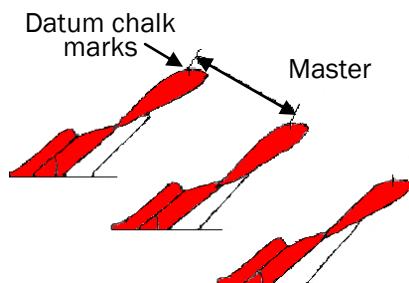

Adjusting left hand mouldboards

To adjust the left hand bodies on a reversible plough, the right hand mouldboard 'throw' has to be known. Using a tape measure note the distance from the 'datum' chalk mark on the right hand 'master' mouldboard to the leg on the body assembly behind—X1.

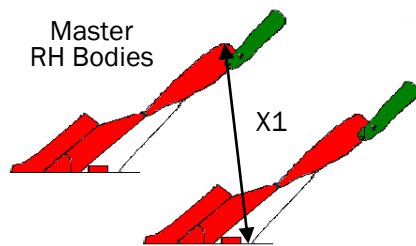

Setting the 'throw' on the left bodies

Repeat the above adjustment on the left hand bodies and adjust the centre mouldboard stay so that the 'throw' is equal to the right hand side—X1. Now adjust the left hand mouldboards in turn, using the centre body as the new left hand 'master'. Measure from the chalk mark on each mouldboard. The mouldboard stay is adjusted accordingly to achieve the correct setting.

Correct mouldboard adjustment is crucial to uniform ploughing.

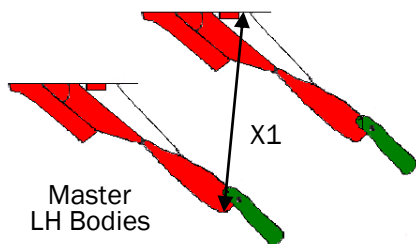

Disc coulters

The disc coulters should be set in a vertical position and 1-2cm wider than the furrow width. Depending on soil conditions, the working depth should be between 4 -10cm maximum.

When working in light soil conditions it may be advantageous to widen the disc coulters to produce a clean furrow wall.

Skim coulters

The skim coulters should work as close to the disc as possible without touching and adjusted with a gap of 3-5mm at the top to prevent trash build-up. The working depth should be set between 2-5cm maximum.

If set too deep, the furrows will be left open and cause unnecessary trash growth.

Frame setting

The plough should be adjusted so that the frame is parallel with the ground and all the bodies ploughing at the same depth. Adjustment is carried out by means of the tractor top link or tractor 3-point linkage.

Frame setting - conventional plough

The plough legs should be set 90deg to the land when in work. Adjustment is by means of the tractor right hand levelling box.

TIP! Do not adjust the front furrow width unless this setting is correct.

Frame setting - reversible plough

Similar to the conventional plough, but the adjustment is by means of the wing (level) adjuster on the plough headstock. The tractor link arms should be equal in length. Tyre pressures must be equal on the same axle for correct setting.

TIP! Do not adjust the front furrow width unless this setting is correct.

Front furrow width adjustment

If the front furrow width differs, adjust by moving the side shift assembly on reversible ploughs or slide the cross shaft to the left or right on a conventional plough. If the correct setting is unobtainable, then the tractor wheel setting will have to be adjusted.

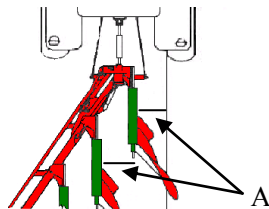
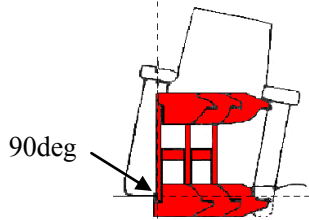
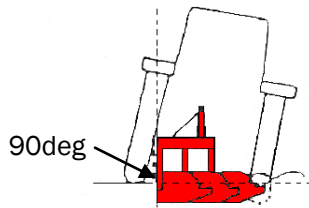
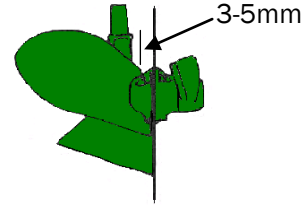
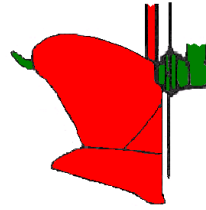

In Field Adjustments



Top link adjustment

For the plough to perform correctly, the top link should be adjusted so that the plough frame is parallel to the ground. Use the 'slotted' hole in the plough headstock with the pin central in the hole during ploughing for tractors with lower link arm sensing. This will allow the plough to move freely during operation and provide quick penetration of the soil at the headlands.

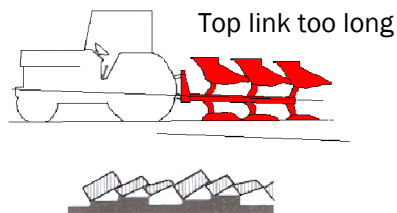
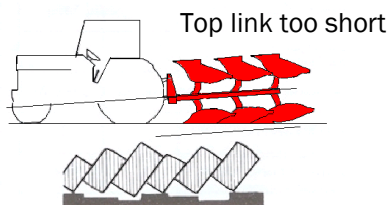
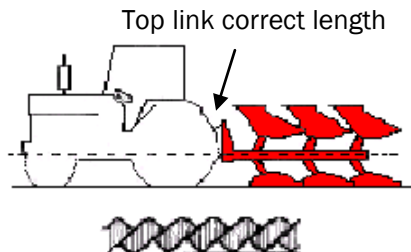

Level adjustment – reversible plough

It is very important the plough legs are upright and 90° to the land being ploughed. This will ensure the plough will penetrate the soil and that all the land is ploughed level and at the same depth. If adjusted incorrectly, the plough will not run straight behind the tractor due to high forces on either the mouldboards or landsides. The furrows will also be uneven in height.

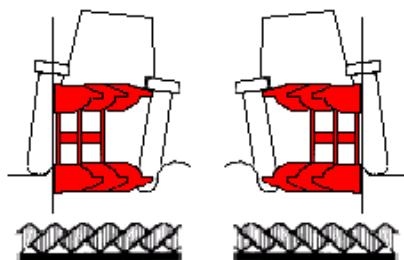

TIP! If the plough fails to penetrate the soil or moves sideways away from its work, always check this adjustment.

Correct level setting with the plough legs 90° to the land being ploughed.

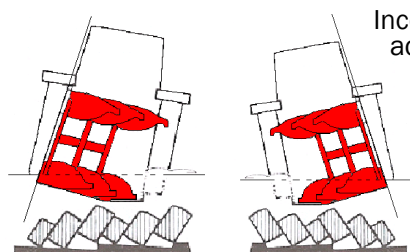

Incorrect level adjustment

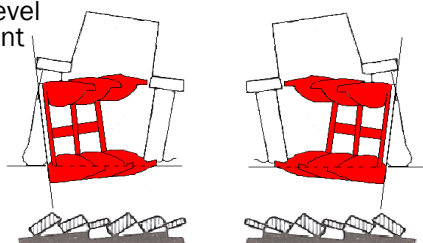

Plough not upright but leaning in towards work in both ploughing directions.

Plough not upright but leaning away from work in both ploughing directions.

Result: poor penetration, wide front furrow, top link out of line with the centre of the tractor and furrows uneven .

Result: narrow front furrow, top link out of line with the centre of the tractor and furrows uneven .

Level adjustment – conventional plough

To ensure the plough is upright (90°) when in work, the right hand tractor lift arm is adjusted.

Shortening the tractor right hand lift arm will cause the plough to lean away from work. The front furrow will also become narrower and shallower.

Lengthening the tractor right hand lift arm will lower the right hand side of the plough into work. The front furrow will become wider and deeper. The plough will be slow to penetrate the soil or move to the left away from work.

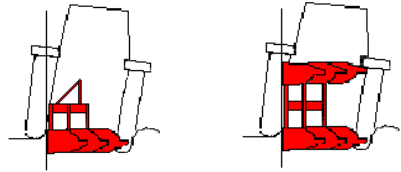
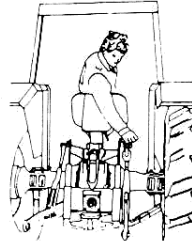

Level adjustment – reversible plough

To ensure the plough is operating upright (90°) in both ploughing directions, the level adjustment is carried out by means of either, independent screw adjusters on the headstock for left and right hand ploughing - ref. A & B, or by a stroke control adjustment on the turn-over cylinder - ref. C.

With the latter adjustment, it may be necessary to shorten or lengthen one of the tractors link arms to ensure equal ploughing on the left and right hand bodies.

Front furrow width setting

Once the plough is working in an upright position, the front furrow width can then be adjusted.

The tractor front and rear inside wheel setting initially control the width of the first furrow, but can also be adjusted by moving the plough to the right or left. This is achieved by a) altering the frame angle to steer the plough, or b) by a parallel slide and rail system. The latter being more advantageous as it allows the plough to pull in a straight line. Changing the frame angle can induce excessive landside or mouldboard pressure and may cause the tractor or plough to 'crab'. **Important:** the plough and tractor must work in line, with the top link running straight behind the tractor.

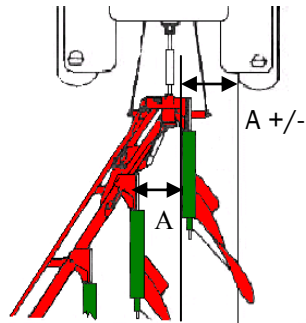
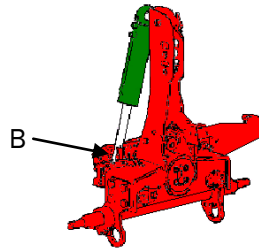
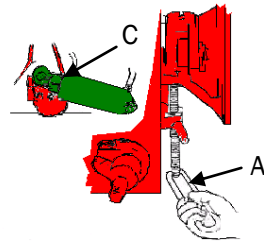

Opening – 2 Furrow – Crown



1st Run

2nd Run

3rd Run

4th Run

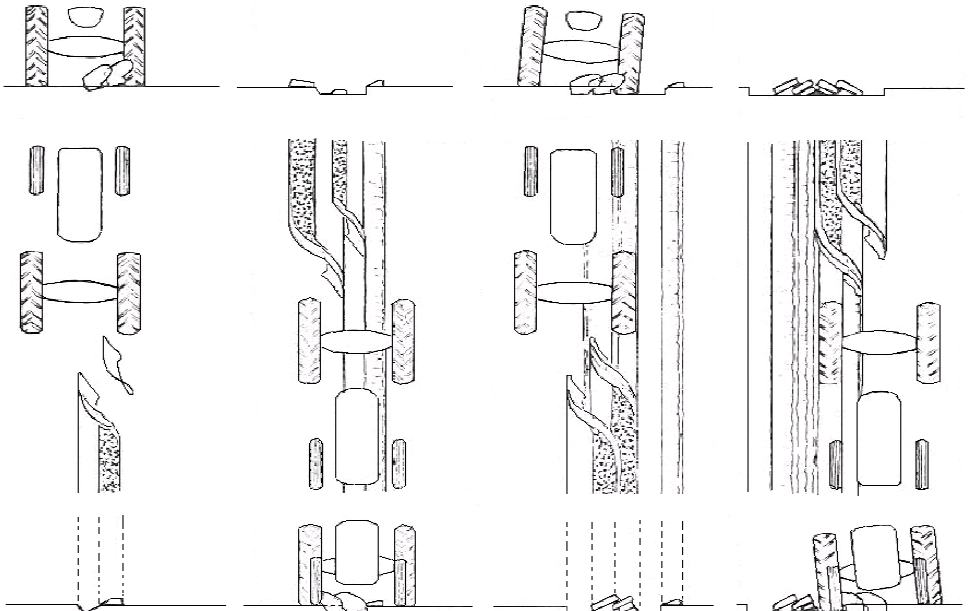

Lengthen the tractor's top link and raise the front body by shortening the front body by shortening the tractor's right hand levelling box. Lower the rear disc coulters and set the depth wheel to plough one third of the intended depth.

TIP! Use sighting poles (3 maximum in competition ploughing) to ensure a straight opening.

The tractor is positioned so that the front body completes the split, leaving the rear body to turn a small amount of soil into the centre of the opening.

Important: All the land must be cut through to prevent any regeneration of residue.

Drive the tractor to the left of the opening and adjust the depth wheel to half the intended depth.

The tractor's top link and right levelling box should be adjusted to level the plough so that the front furrow is laid up to the centre of the opening, leaving all furrows level.

Set the disc and skims coulters as per 'Basic Field Settings'.

The small furrow in the centre of the opening will support the crown being laid.

With the plough setting similar to the third run, drive the tractor on the opposite side of the opening.

Adjust the tractor's top link and levelling box to ensure all the furrows are level and equal in size.

Opening – Double Split – Crown

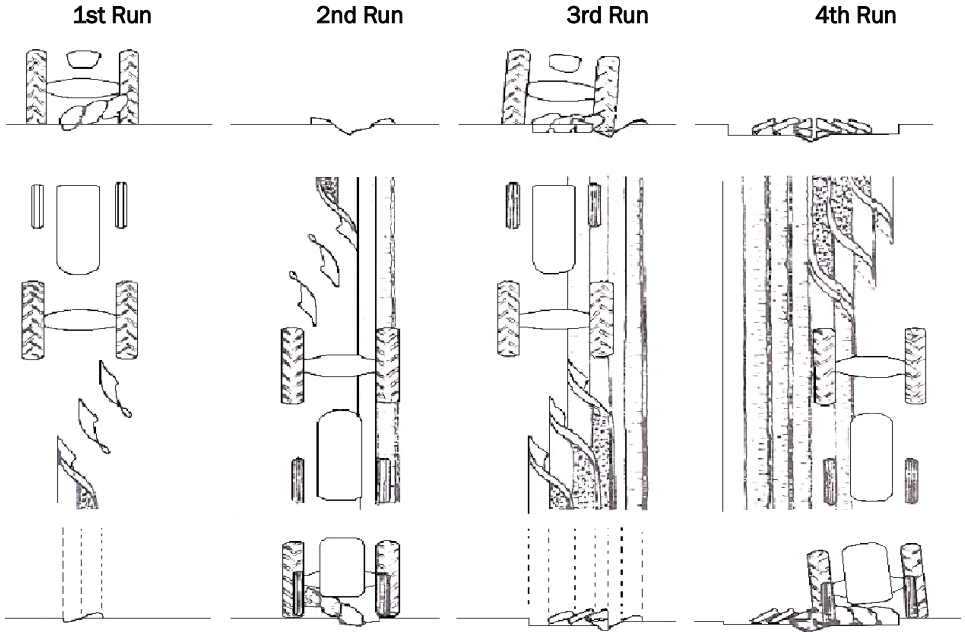

Lengthen the top link and raise the front body by adjusting the tractor's right hand levelling box.

Lower the rear disc coultter and set the depth wheel to plough one third of the intended depth.

TIP! Use sighting poles (3 maximum in competition ploughing) to ensure a straight opening.

The tractor is positioned so that the rear body completes the split, with the depth increased to give stability to the plough.

Important: All the land must be cut through to prevent any re generation of residue.

Drive the tractor on the left of the opening and adjust the depth wheel to the intended depth.

The tractor's top link and right levelling box should be adjusted so that the front furrow is laid up to the centre of the opening, leaving all furrows level.

Alternatively, position the tractor so only half the first furrow width is turned. This provides a support for the second furrow to lay on.

With the plough setting similar to the third run, drive the tractor on the opposite side of the opening.

Adjust the tractor's top link and levelling box to ensure all the furrows are level and equal in size.

Opening – Commercial – Crown



1st Run

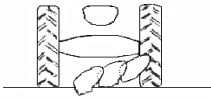

2nd Run



3rd Run

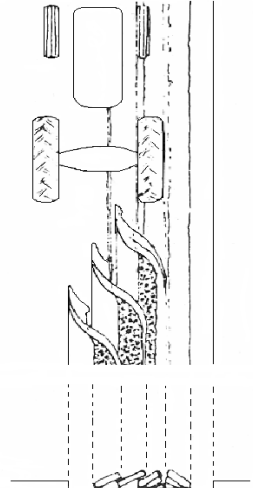
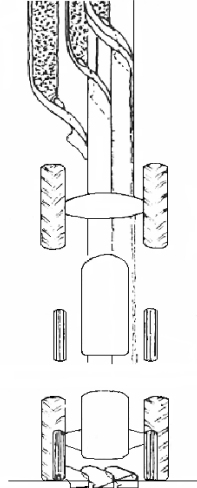
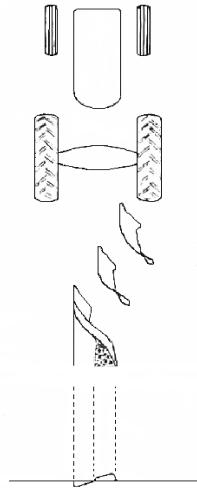

Lengthen the top link and raise the front body by adjusting the tractor's right hand levelling box.

Lower the rear disc couler and set the depth wheel to plough one third of the intended depth.

TIP! Use sighting poles (3 maximum in competition ploughing) to ensure a straight opening.

The tractor is positioned so that the front body completes the split, leaving the second body to turn a small amount of soil into the centre of the opening. The third furrow is now placed to form half the crown.

Depending on the number of furrows, The remaining furrows follow at normal ploughing depth.

The tractor's top link and levelling box should be adjusted to ensure all the furrows are level.

Drive the tractor to the left side of the opening and adjust the depth wheel to normal ploughing depth.

The tractor's top link and right levelling box should now be adjusted to level the plough so that the front furrow is laid up to the centre of the opening, leaving all furrows level.

Disc and skims coulters are set as per 'Basic Field Settings'.

Finish – Mounted Plough

Penultimate Run

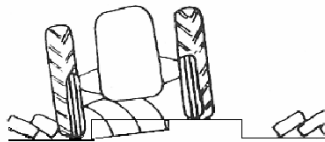
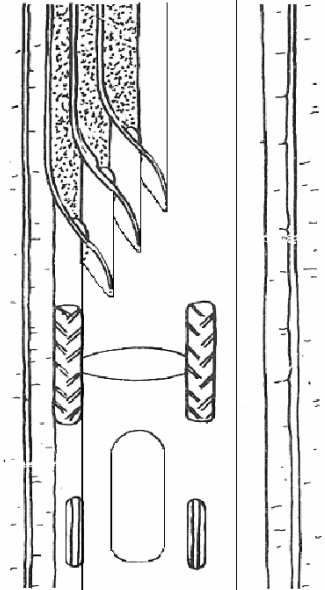
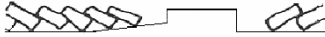

Last Run

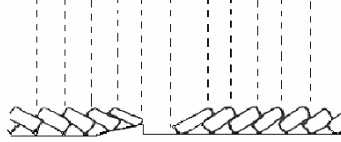
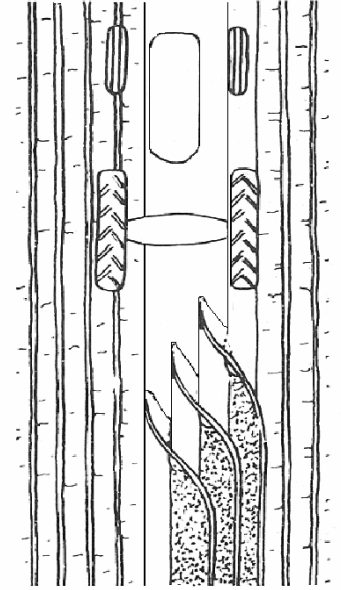
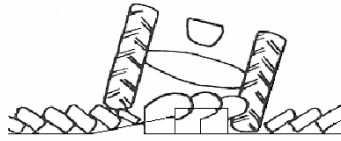

Shallow the rear body and lower the rear disc coulters and set the depth wheel to one third of normal depth.

Measurements must be taken prior to this run to ensure the remaining unploughed land is parallel and one furrow less in width than the number of bodies on the plough.

The tractor's top link and levelling box should be adjusted to ensure all furrows are level.

The depth wheel is adjusted to allow the plough to work at normal ploughing depth.

With the tractor positioned so that the finishing furrows lean towards the crown, adjust the top link and levelling box to ensure all furrows are level.

The disc coulters on the rear furrow should be lowered to enable the furrow bottom to be left clean.

TIP! The last furrow should be ploughed towards the opening.

Finish — Semi-Mounted Plough



Penultimate Run

Last Run

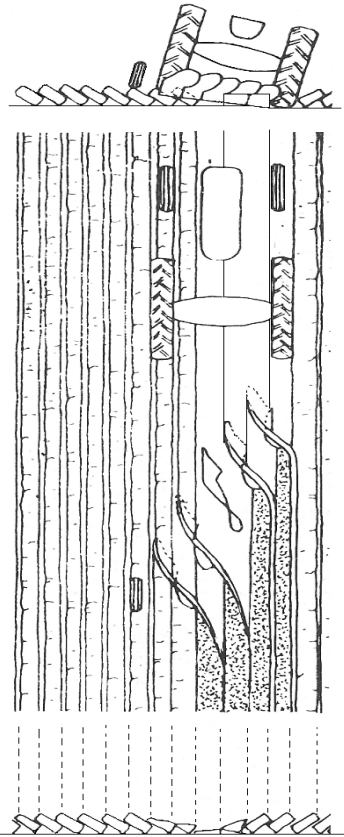
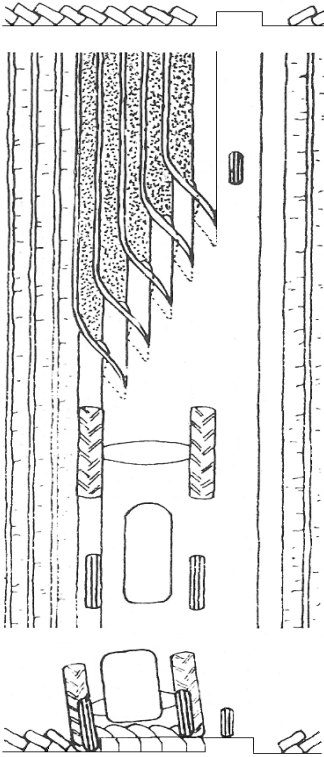

The penultimate run should be ploughed at full depth as other preceding bouts. Depending on the size of the plough, measurements must be taken prior to this run to ensure that the number of furrows left is less than the complete plough.

The tractor is positioned as for normal ploughing, but the rear wheel assembly is adjusted so that the rear furrows are at one third ploughing depth to leave a shallow neat finish.

TIP! For an 8 furrow plough, leave only 4-5 furrows of un-ploughed land. The rear of the plough should be raised to prevent already ploughed land from being inverted.

Opening – Reversible Plough

1st Run

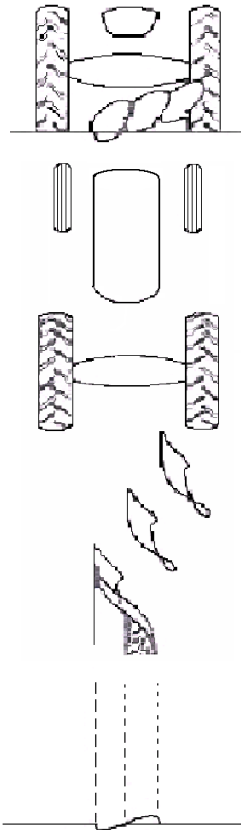

2nd Run

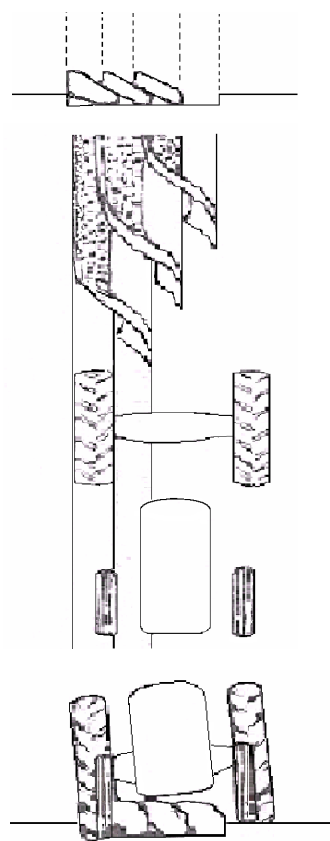

Lengthen the top link and raise the front body by adjusting the tractor's 3-point linkage. If the plough bodies rotate over the main frame during plough reversal, it is possible to use the turnover system to turn the plough slightly away from work to avoid a deep start and prevent other bodies catching the ground.

Lower the rear disc coulters and set the depth wheel to plough one third of the intended depth.

TIP! Use sighting poles (3 maximum in competition ploughing) to ensure a straight opening.

Using the right hand bodies, the tractor is positioned for normal ploughing by driving down the open furrow bottom.

Raise the rear disc coulters and set the depth wheel to plough at the required ploughing depth.

During operation the opening furrow is inverted back to its start position. Adjust the tractor 3-point linkage control so that the first furrow height is equal to all the remaining furrows.

Finish – Reversible Plough



Penultimate Run

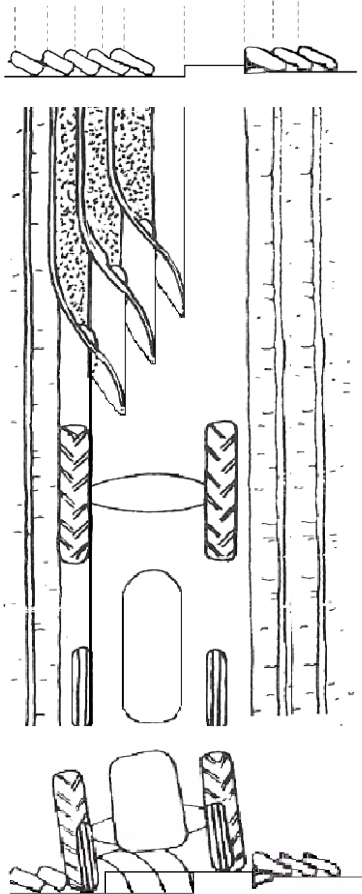

Last Run

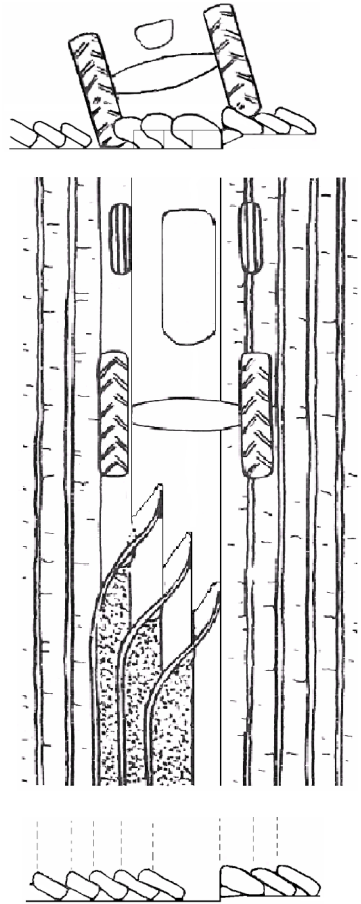

Accurate measurements must be taken prior to this run. This is to ensure the remaining unploughed land is parallel and exactly equal to multiples of the overall ploughing width.

Continue as with normal ploughing with all furrows working at the same depth. If the remaining unploughed land is parallel and its measurement equal to the overall ploughing width, the rear disc coulters will cut a clean furrow without entering the already ploughed land.

TIP! Measure the unploughed land well in advance of the last round to ensure it is parallel and straight.

| Problem | Cause | Correction |
|---|--|--|
| <p>Poor penetration</p> <p>TIP! Always use the correct share for the width of ploughing. The share's cutting width should be 2" less than the furrow width of the plough to allow the soil to pivot as it is inverted.</p> <p>Example: 16" ploughing use 14" shares</p> | <ul style="list-style-type: none"> ● Worn shares or points ● Plough leaning into work ● Discs set too deep ● Top link too long ● Tractor draft control setting | <ul style="list-style-type: none"> ⇒ Fit new shares & points ⇒ Reset level adjustment so plough is 90° to land ⇒ Raise disc coulters ⇒ Shorten top link ⇒ Reduce response setting |
| <p>Rear body ploughing shallow and plough pulling to the left (RH bodies)</p> | <ul style="list-style-type: none"> ● Plough leaning into work ● Front tractor wheel settings too wide ● Plough not level ● Damaged components | <ul style="list-style-type: none"> ⇒ Reset level adjustment so plough is 90° to land ⇒ Check operator's manual ⇒ Adjust tractor top link ⇒ Check plough alignment |
| <p>Tractor difficult to steer</p> <p>TIP! Normally caused by the plough 'crabbing' due to being out of line with the tractor</p> | <ul style="list-style-type: none"> ● Tractor front too light ● Bodies out of line ● Cross shaft position ● Tractor stabilisers or check chains too tight ● Tractor wheel setting too wide or narrow | <ul style="list-style-type: none"> ⇒ Add front end weight ⇒ Check plough alignment ⇒ Cross shaft cranks must be upright on conventional ploughs ⇒ Adjust so plough can float freely (mounted ploughs) ⇒ Check operator's manual |
| <p>Narrow front furrow</p> <p>TIP! When using a tractor with wide tyres, it may be necessary to adjust the front furrow width narrower to ensure uniform and level ploughing.</p> | <ul style="list-style-type: none"> ● Tractor wheel setting too narrow ● Cross shaft position ● Disc coulter setting ● Tractor stabilisers too tight ● Damaged components | <ul style="list-style-type: none"> ⇒ Check operator's manual ⇒ Adjust as required ⇒ Adjust as required ⇒ Adjust so plough can float freely (mounted ploughs) ⇒ Check plough alignment |
| <p>Wide front furrow</p> <p>TIP! Never operate the plough deep on the front furrow to fill in the hole left by wide tractor tyres. To cater for wide tyres, narrow the front furrow to allow it to be supported by the rear furrow of the previous round. If the second furrow is high, it is an indication the front furrow is too wide.</p> | <ul style="list-style-type: none"> ● Tractor wheel setting too wide ● Cross shaft position ● Disc coulter setting ● Tractor stabilisers too tight ● Damaged components | <ul style="list-style-type: none"> ⇒ Check operator's manual ⇒ Adjust as required ⇒ Adjust as required ⇒ Adjust so plough can float freely (mounted ploughs) ⇒ Check plough alignment |

Trouble Shooting



| Problem | Cause | Correction |
|---|---|---|
| <p>Uneven furrows</p> <p>TIP! If the plough is protected by shear bolts always check these first to ensure a bolt is not half sheared. To find half sheared bolts, loosen and check if the bolt can be rotated through 360deg. If bent, the bolt will not rotate.</p> | <ul style="list-style-type: none"> ● Incorrect interbody setting ● Skim adjustment ● Discs setting ● Mouldboard height adjustment ● Plough not level ● Incorrect front furrow depth or width ● Damaged leg or saddle | <ul style="list-style-type: none"> ⇒ Check mouldboard position ⇒ Adjust so that all work at the same depth and in the same position ⇒ Set to work at the same width and depth ⇒ Adjust mouldboard height and spacing ⇒ Reset level adjustment ⇒ Width and depth must be equal on all bodies ⇒ Check plough alignment |
| <p>Damaged saddle or leg</p> | <ul style="list-style-type: none"> ● Contact with large obstacle | <ul style="list-style-type: none"> ⇒ Ensure all legs and saddles are in line. Use string or eye to check for misalignment |
| <p>Furrows rolling back</p> | <ul style="list-style-type: none"> ● Furrows too deep for the width of ploughing ● Top link too short ● Mouldboards adjusted too far back | <ul style="list-style-type: none"> ⇒ Reduce depth or increase furrow width ⇒ Lengthen top link ⇒ Adjust mouldboards to correct position |
| <p>Broken or misplaced furrows</p> | <ul style="list-style-type: none"> ● Skim coulters set too square or too deep | <ul style="list-style-type: none"> ⇒ Adjust skims to correct working depth and angle |
| <p>Trash not being buried correctly</p> <p>TIP! As time is required for trash to fall down into the furrow bottom, a plough can only operate at the speed of the skimmer. Long interbody clearance can help increase ploughing speed.</p> | <ul style="list-style-type: none"> ● Skim coulters set too deep or are working too far away from disc ● Ploughing too fast for skimmer operation | <ul style="list-style-type: none"> ⇒ Adjust skims to correct working depth and position in relation to disc coulters ⇒ Slow forward speed to allow skimmed soil to be buried |
| <p>Front furrow low or second furrow too high</p> <p>TIP! The first furrow must be supported by the previous rear furrow. If low, it will sit under the furrow behind and produce a high second furrow.</p> | <ul style="list-style-type: none"> ● Tractor tyres too wide for the width of furrow bottom ● Front furrow width too wide | <ul style="list-style-type: none"> ⇒ Narrow the front furrow width so that it is supported by the last furrow of the previous round ⇒ Adjust the width of first furrow |



Only patience, practice and experience can make a good ploughman and although even a novice can recognise well ploughed land, the finer points of this skill are not obvious to the untrained eye and can only be fully appreciated by an expert.

Kverneland Group (UK) Ltd.

Walkers Lane, Lea Green, St Helens, Merseyside, WA9 4AF

Tel: 01744 853 200

Fax: 01744 853 400

Internet: www.kvernelandgroup.com

A1 0507-V3

Copyright © Kverneland Group